

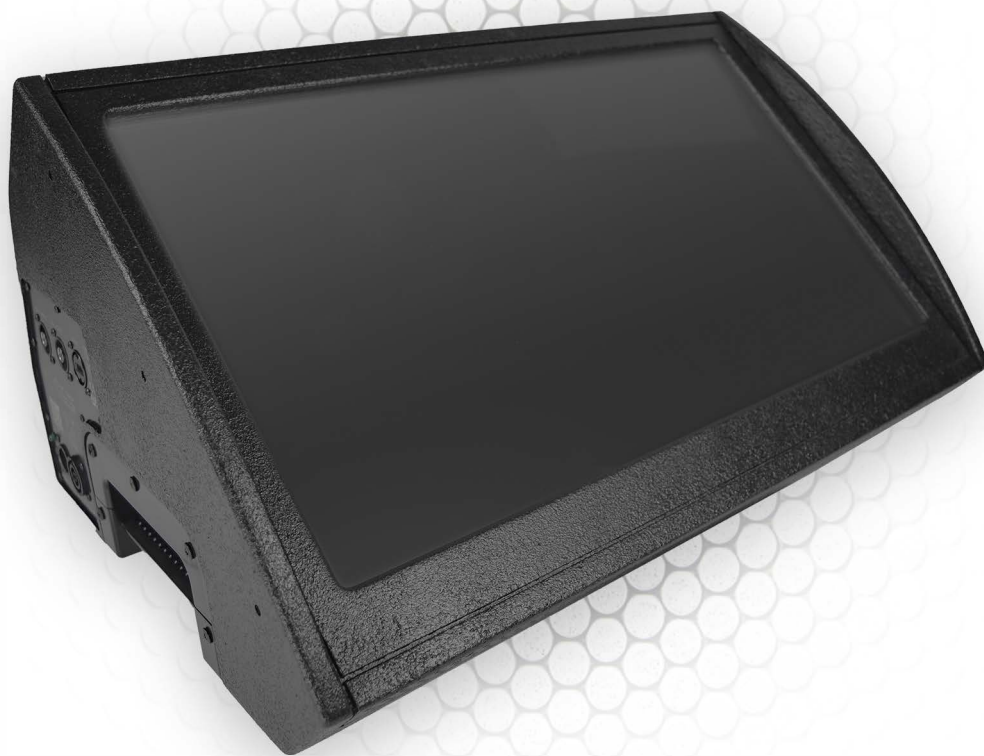

Acoustic Precision Technologies GB



TCM

Quick Start Guide

Tel: +44 (0) 1579 212210
Email: info@apt-gb.com
Website: www.apt-gb.com

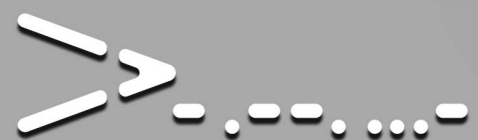

>Teleprompter.Video

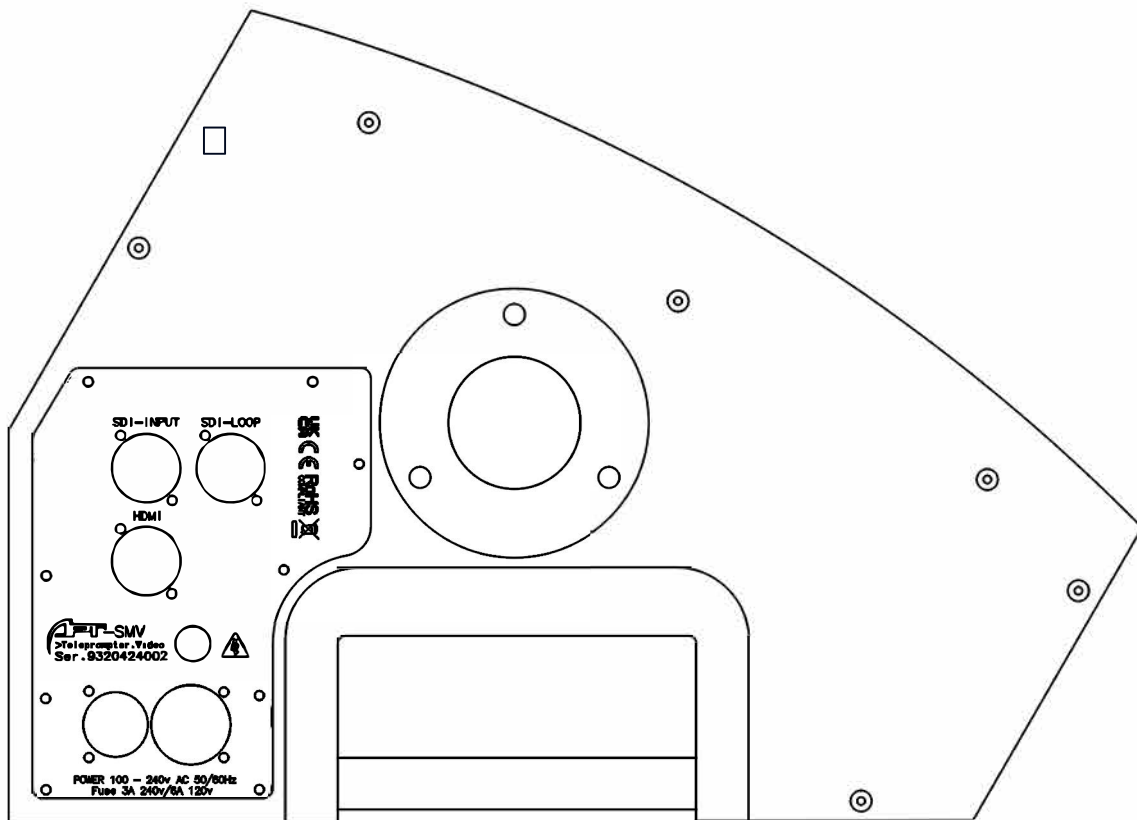
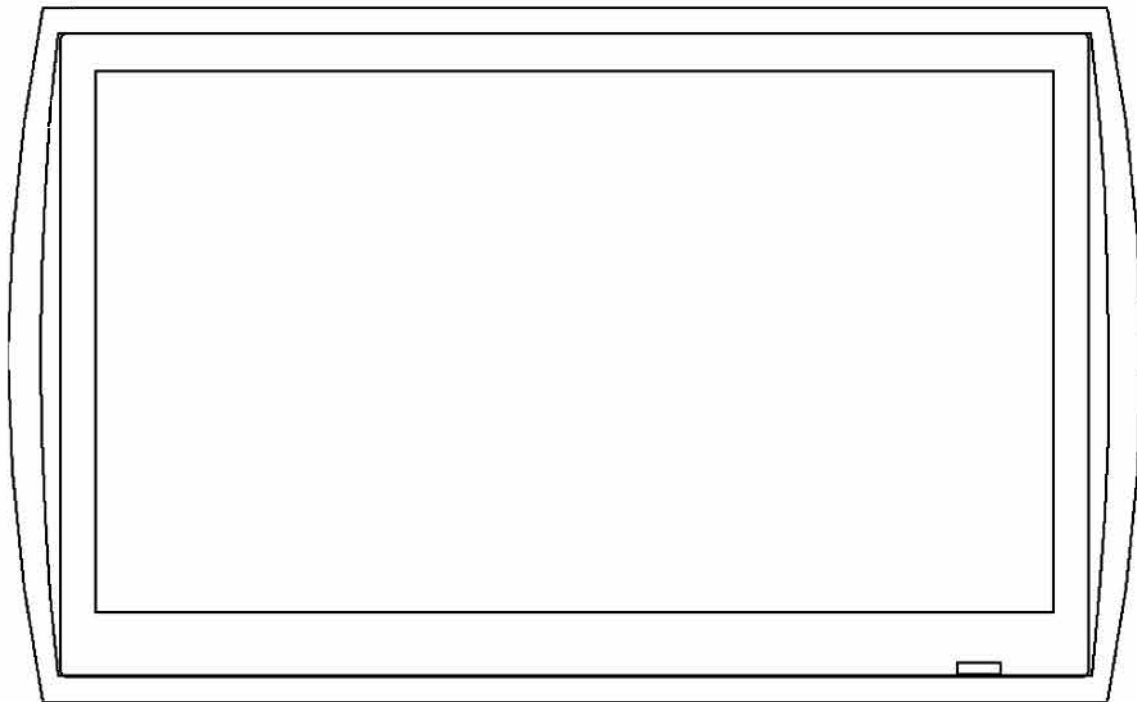

CONNECTIONS

SDI-INPUT

75Ω Coaxial Max 100m Cable*

HDMI Input

20m Cable Max Recommended

Power In

100-240VAC 50-60Hz

SDI-LOOP

75Ω Coaxial Max 100m Cable*
(Recommended Max 10. Units)**

Power Out

100-240VAC 50-60Hz
(Recommended Max 10. Units)**

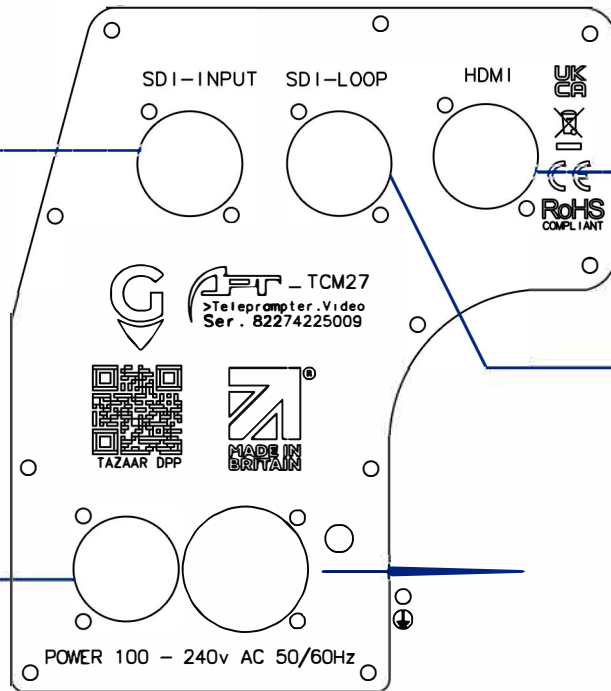

*Cable lengths are a recommended guide only based on Protocol Standards, 10m between units is recommended.

**Signal issues may exist on longer cable runs and higher resolution images,

*** Inrush power over 10 Units can cause nuisance tripping of safety devices

INPUT FUSE

240v 3A/110v 6A
20mm X 5mm, Glass
Fuse Located Below Screen

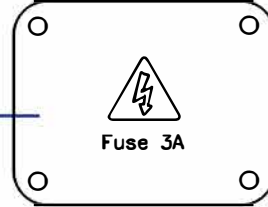

Brown - Live (Hot)

Blue - Neutral

Green or Green/Yellow - Earth (ground)

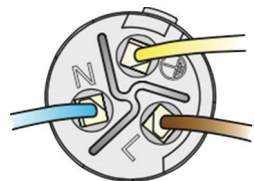

Wiring	VDE	UL
L ⇒	brown	black
N ⇒	blue	white
⊥ ⇒	green/yellow	green



ASSEMBLY INSTRUCTION | powerCON TRUE1

Tel: +44 (0) 1579 212210
Email: info@apt-gb.com
Website: www.apt-gb.com



>Teleprompter.Video

CONNECTION EXAMPLES

SDI & Power Links

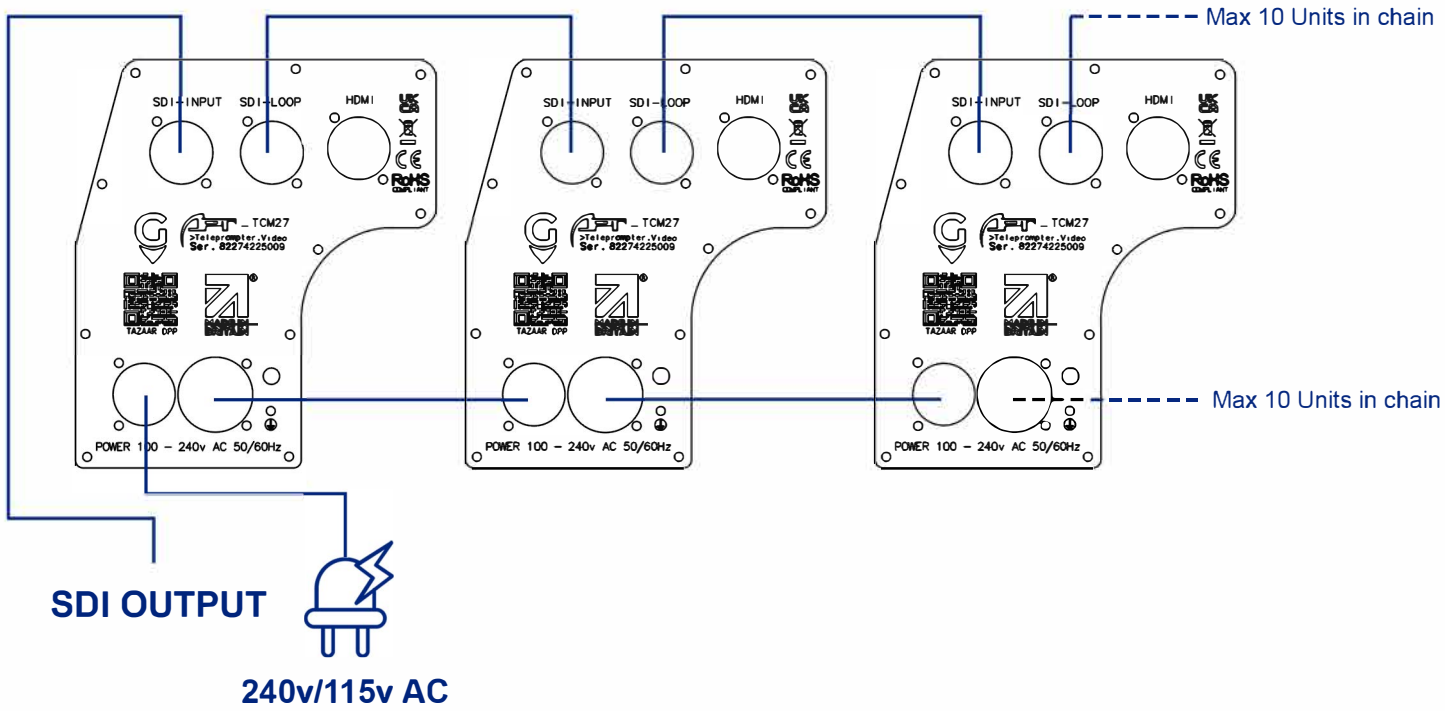

HDMI & Power Links

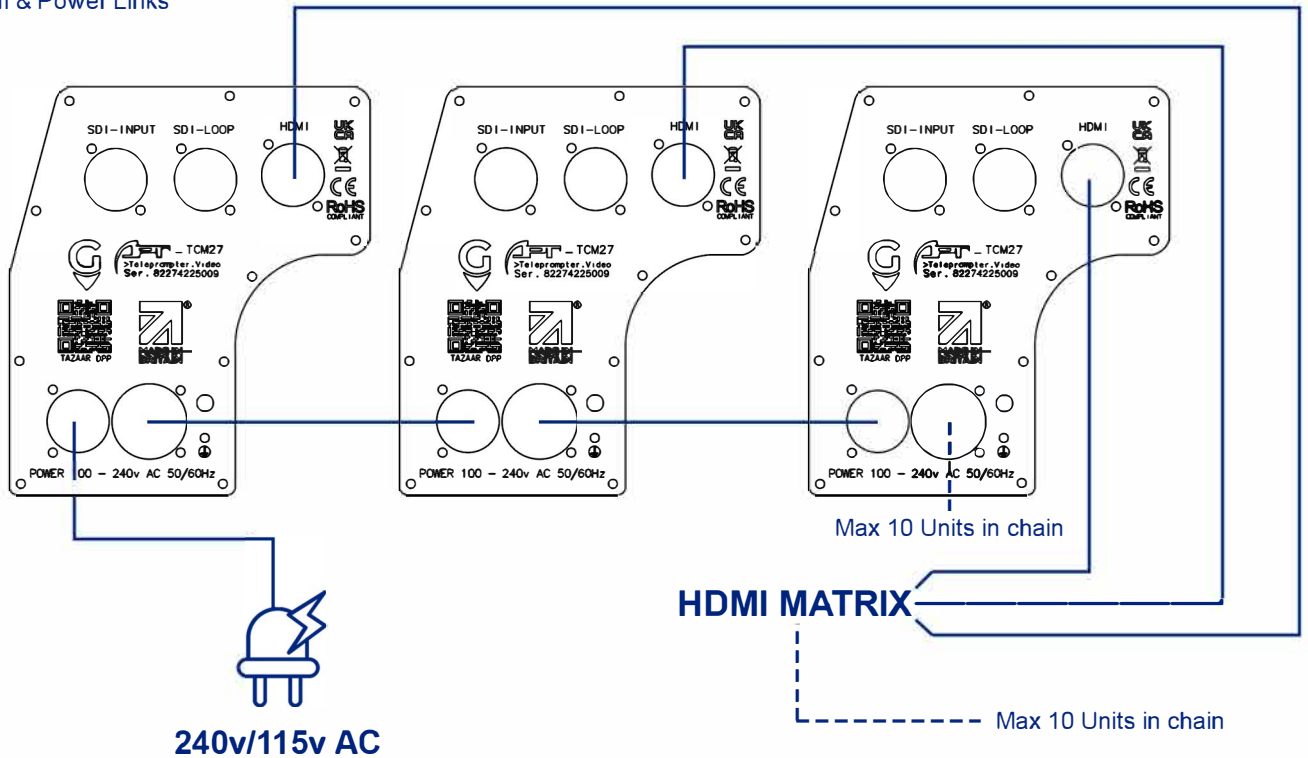

Please note only one input connection configuration can be used at a time
i.e if using SDI-IN you can not use HDMI-IN,
When using HDMI-IN you can not use SDI-IN.



- 1 Once plugged in, a red LED should turn on.
This means your GeoTag is powered
- 2 Scan the QR code on the device to activate your GeoTag.

You will get a welcome email with everything you need, including how to guides and support info,
- 3 It can take time to connect to satellites.

Take your GeoTag outside for 10 minutes for best results.

Don't worry if your location doesn't show immediately, it will soon!

Important safety instructions

Please read the following instructions carefully. Be sure that your Teleprompter is electrically rated to operate with the AC power available in your location.

1. To clean the Teleprompter monitor screen:
 - (a) Turn off the Teleprompter and unplug the power cord.
 - (b) Carefully remove acrylic protection cover (if fitted)
 - (c) Spray a non-solvent, non-abrasive cleaning solution onto a clean, lint free cloth and clean the screen gently. Be sure to lightly blot the surface, rather than applying pressure as you clean.
 - (d) NEVER SPRAY OR POUR ANY LIQUID DIRECTLY ONTO THE SCREEN OR CASE.
 - (e) PLEASE DO NOT USE ANY AMMONIA OR ALCOHOL-BASED CLEANERS ON THE Teleprompter DISPLAY SCREEN OR CASE.
 - (f) APT-GB will not be liable for damage resulting from use of any ammonia or alcohol-based cleaners or improper cleaning practice.
2. Do not place the Teleprompter near a window. Exposing the Teleprompter to rain, moisture or sunlight can severely damage it.
3. Do not apply pressure to the screen, or protective cover. Excessive pressure may cause permanent damage to the display. And/Or injury to persons
4. Do not remove the cover or attempt to service this unit yourself. An authorized technician should perform servicing of any nature.
5. Store the Teleprompter in a room with a temperature of -20° to 60° C (-4° to 140° F). Storing the Teleprompter outside this range may result in permanent damage.
6. Immediately unplug and do not use your Teleprompter and call an authorized technician if any of the following circumstances occur:
 - Power cable cable is frayed or damaged.
 - Connector plate has damage
 - The Teleprompter case is damaged.
 - Liquid spills onto the Teleprompter or the Teleprompter is exposed to rain

APT-GB and its parent company GGPM Ltd. accept no responsibility for any damage, personal injury or death arising out of or associated with the use of any teleprompter video product. E. & O.E.

Regulations and safety notices FCC notices

This device has been tested and found to comply with the limits for a Class B digital device pursuant to Part 15 of the FCC rules. These limits are designed to provide reasonable protection against harmful interference in a residential installation. This device generates, uses, and can radiate radio frequency energy and, if not installed and used in accordance with the instructions, may cause harmful interference to radio communications. However, there is no guarantee that interference will not occur in a particular installation. If this device does cause harmful interference to radio or television reception, which can be determined by turning the device off and on, the user is encouraged to try to correct the interference by one or more of the following measures:

- Increase the separation between the device and receiver.
- Connect the device into an outlet on a circuit different from that to which the receiver is connected.
- Consult the dealer or an experienced radio/television technician for help.

CE declaration of conformity

Hereby, APT-GB., declares that this Teleprompter is in compliance with the essential requirements and other relevant provisions of EMC Directive 2014/30/EU, Low Voltage Directive 2014/35/EU, and RoHS Directive 2011/65/EU and Directive 2009/125/EC with regard to establishing a framework for the setting of ecodesign requirements for energy-related product

Notice: Shielded cables:

All connections to other computing devices must be made using shielded cables to maintain compliance with EMC regulations.

Notice: Peripheral Devices:

Only peripherals (input/output devices, terminals, printers, etc.) certified to comply with the Class B limits may be attached to this equipment. Operation with non-certified peripherals is likely to result in interference to radio and TV reception.

Caution

Changes or modifications not expressly approved by the manufacturer could void the user authority, which is granted by the Federal Communications Commission, to operate this product.

Operation conditions

This device complies with Part 15 of the FCC Rules. Operation is subject to the following two conditions: (1) this device may not cause harmful interference, and (2) this device must accept any interference received, including interference that may cause undesired operation.

Notice: Canadian users

This Class B digital apparatus complies with Canadian ICES-003. Remarque a l'intention des utilisateurs canadiens Cet appareil numerique de la classe B est conforme a la norme NMB-003 du Canada. Disposal of waste equipment by user in private household in the European Union

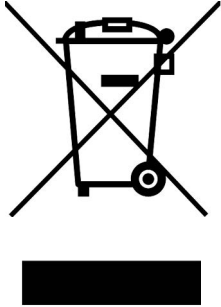

This symbol on the product or on its packaging indicates that this product must not be disposed of with your other household waste. Instead, it is your responsibility to dispose of your waste equipment by handing it over to a designated collection point for the recycling of waste electrical and electronic equipment. The separate collection and recycling of your waste equipment at the time of disposal will help to conserve natural resources and ensure that it is recycled in a manner that protects human health and the environment. For more information about where you can drop off your waste equipment for recycling, please contact your local city office, your household waste disposal service or the shop where you purchased the product

Tel: +44 (0) 1579 212210
Email: info@apt-gb.com
Website: www.apt-gb.com

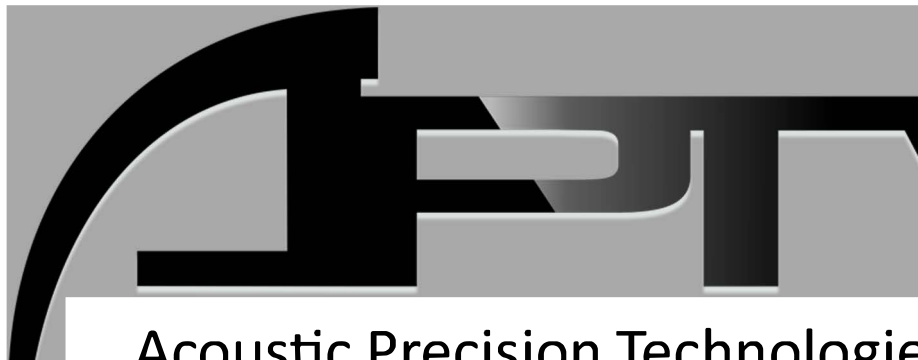

Acoustic Precision Technologies GB